

Article number: 2310431057
Description: E+G Levelling elements
LX.30-SW17-M8X16

Measures

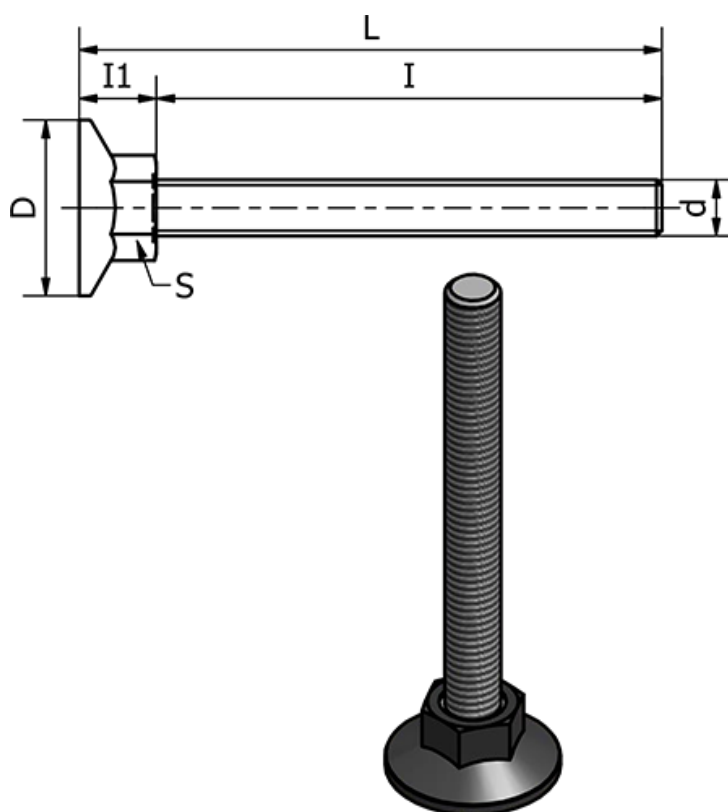

d	= M8
D	= 30
I	= 16
I1	= 12
L	= 28
S	= 17
Static load in (N)	= 2500
Type	= Forzinket

Weight (g) = -